







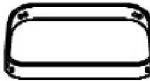

= Furniture Solutions =

Melia Table – 70x70cm

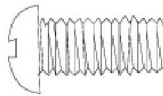
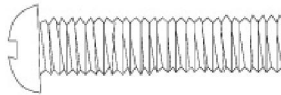
Part NO.	DESCRIPTION	PICTURE	QTY
A	TILE		4
B	TABLE RIM		1
C	LEG CONNECTOR BRACKET		1
D	TABLE LEG		4
E	SHORT BOLT(M6X15MM)		4
F	LONG BOLT(M6X30MM)		8
G	WASHER		12
H	BOLT COVER		12
I	HEX SCREW DRIVER		2
J	TOUCH-UP PAINT BOTTLE		1

NOTE: For ease of assembly, it is necessary for two people to assemble this table!

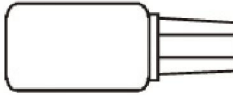
1. Carefully remove tile and set-aside until Step 5. Lay tile flat--do not stand tile on edge. Remove all protective materials and set parts on a flat, non-abrasive surface. Identify parts packed in carton against the parts list. **Do not attempt assembly if any parts are missing or damaged.**

2. Place the table rim (without tile) (B) upside down on a flat, non-abrasive surface. Attach table leg (D) to rim (B) using short bolt (E) and washer (G). Guide bolt (E) through hole in table leg (D), into pre-drilled hole in the table rim (B). Hand tighten three to four turns only. **Do not tighten completely.** Some adjustments may be necessary to ensure proper alignment of the table legs. Repeat for other three legs. (Figure1)

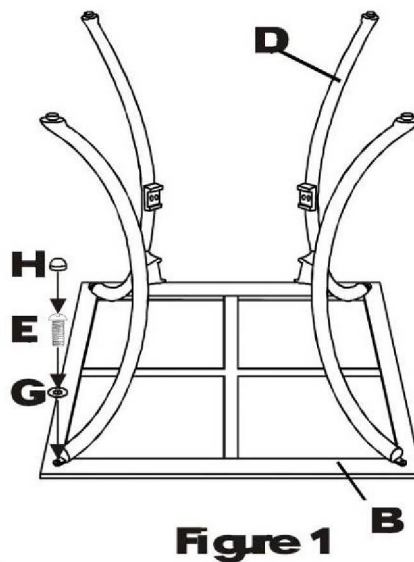

3. Attach table leg (D) to the leg connector bracket (C) using long bolt (F) and washer (G) (each leg has two bolts). (Figure2)

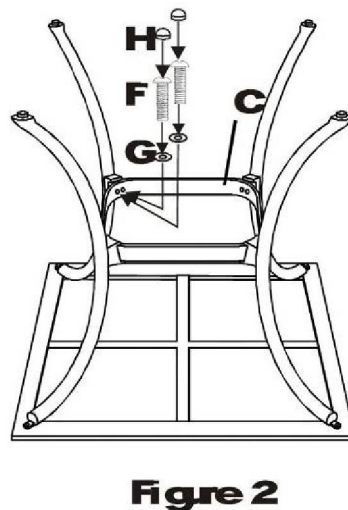

4. After making any necessary adjustments to the alignment of the table legs (D) and the leg connector bracket (C), use the screwdriver (I) to tighten all bolts. Note: each bolt must be tightened a few revolutions at a time. In order to apply equal pressure to all bolt joints, we recommend working in a cross corner (X fashion). Repeat until all bolts are tight. **Do not over tighten.** Over tightening may strip bolts. Cover all Bolts with bolt covers (H).

5. With the help of another person, turn the table in the upright position. Note the bumpers spaced evenly throughout the inside of the rim. Carefully place tile inside the rim, resting on the bumpers.

Note: Do not force the tiles to fit. If the tile does not easily fit into place, rotate the tile a quarter turn at a time until it fits easily into place. You may also try to fit the tile into a different square within the rim. (Figure3)



Figure 3

Your table is now ready for use.

NOTE: Repeated assembly can weaken the locking ability of the washers. Periodically check all bolted connections on your furniture to make sure they are tight and secure. Retain these instructions for future reference.

CARE & MAINTENANCE

Your table should be washed with a mild solution of soap and water. Rinse with clean water and dry with a soft towel. DO NOT use bleach or strong solvents to clean any of your patio furniture. **DO NOT DRAG TABLE ALWAYS LIFT WITH HELP OF ANOTHER PERSON.**

STORAGE SUGGESTIONS

Always be sure to drain any water accumulated on the furniture. The best way to maintain your furniture & cushions is store them in dry areas out of the elements. Covering is recommended with commercially available furniture covers, when your furniture is not in use.

Using your furniture under cover is recommended.

Made In China

Imported By Furniture Solutions (Aust) Pty Ltd