







= Furniture Solutions =

Bahamas Dining Table 180x105cm

NO.	PICTURE	DESCRIPTION	QTY
A		GLASS	2
B		TABLE RIM	1
C		TABLE LEG	4
D		WASHER	4
E		SPRING PAD	4
F		ALLEN WRENCH	1
G		SCREW M10	4
H		LEG CAP	4

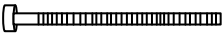
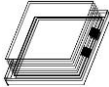
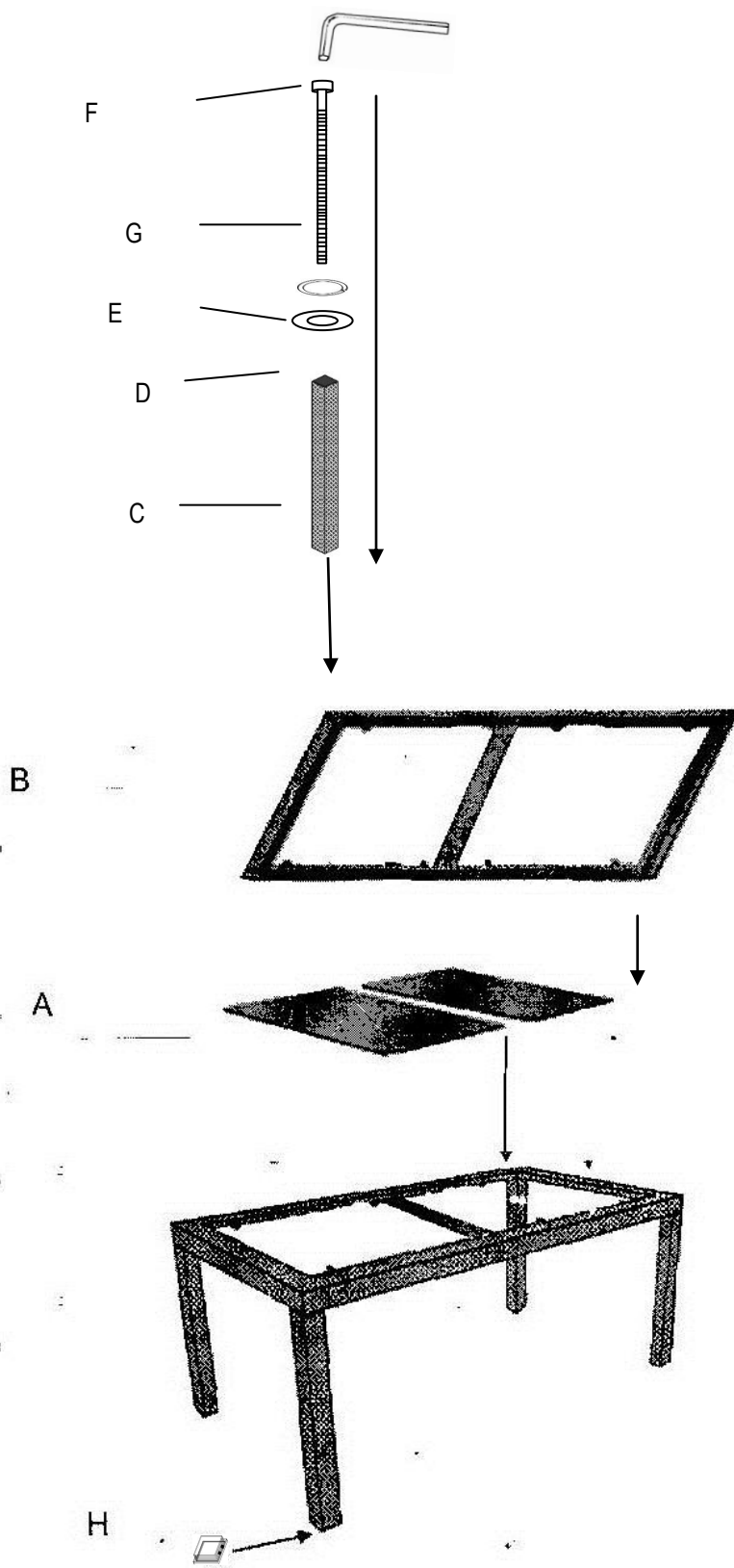

1. CAREFULLY PLACE THE TABLE RIM (B) ON A SOFT SURFACE WITH THE UNDERSIDE FACING UP.
2. ATTACH TABLE LEGS (C) TO THE TABLE TOP (B) USING SCREWS (G) WITH PARTS (D) & (E) AS SHOWN IN DIAGRAM ABOVE. TIGHTEN WITH (F) ALLEN KEY.
3. INSERT PART (H) INTO BASE OF LEG.
4. WITH THE HELP OF ANOTHER PERSON, CAREFULLY TURN THE TABLE IN THE UPRIGHT POSITION AND PUT THE GLASS INSERTS (A) INTO TABLE RIM (B).
5. YOUR TABLE IS NOW READY TO USE.

CARE & MAINTENANCE

YOUR TABLE SHOULD BE WASHED WITH A MILD SOLUTION OF SOAP AND WATER. RINSE WITH CLEAN WATER AND DRY WITH A SOFT TOWEL. DO NOT USE BLEACH OR STRONG SOLVENTS TO CLEAN ANY OF YOUR PATIO FURNITURE.

GLASS IS NOT COVERED UNDER WARRANTY.

DO NOT DRAG TABLE. ALWAYS LIFT WITH HELP OF ANOTHER PERSON.

STORAGE SUGGESTIONS

ALWAYS BE SURE TO DRAIN ANY WATER ACCUMULATED ON THE FURNITURE. THE BEST WAY TO MAINTAIN YOUR FURNITURE & CUSHIONS IS STORE THEM IN DRY AREAS OUT OF THE ELEMENTS.

COVERING IS RECOMMENDED WITH COMMERCIALY AVAILABLE FURNITURE COVERS, WHEN YOUR FURNITURE IS NOT IN USE.

USING YOUR FURNITURE UNDER COVER IS RECOMMENDED.

*** PLEASE REFER TO YOUR WARRANTY SWING TAG FOR FURTHER MAINTENANCE REQUIREMENTS.**

Made In China

Imported By Furniture Solutions (Aust) Pty Ltd